

# PCB 插片 (250/6.3防倒直型PCB插片)

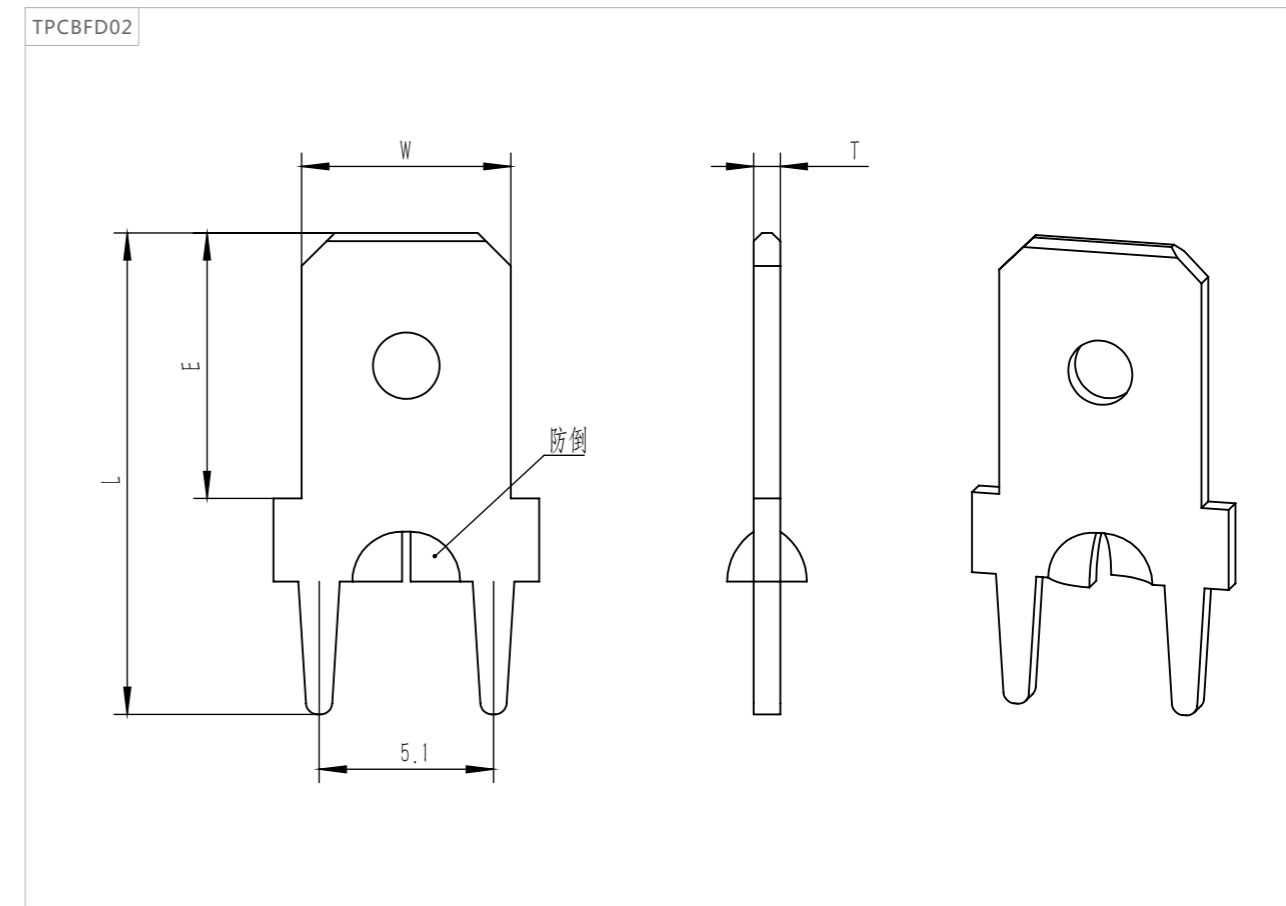

图号 Fig	品名编号 Part NO.	尺寸 Dimension(mm)				适用电线 WireRange (AWG#)	材质 Material	连接方式 Connection	数量 Q'TY (pcs/r)	备注 Remarks
		W	E	L	T					
TPCBFD02	T63008FDPCB-BL	6.35	7.9	14	0.8		H65铜	单粒	5K	